

PCB Design for Manufacture V1.1

From [seedstudio](https://www.seedstudio.com)

CONTENTS

1. Brief Introduction.....	3
2. Seed Fusion PCB Specification.....	4
2.1 Required Manufacturing Files.....	4
2.2 PCB Gerber File.....	4
2.3 PCB Specification for FR4-TG130.....	5
3. PCB Lamination Structure.....	8
3.1 Layer Structure.....	8
4. PCB Dimensions Specification.....	9
4.1 Manufactured PCB Dimensions.....	9
5. Surface Treatments.....	10
5.1 Hot Air Solder Leveling (HASL).....	10
5.1.1 Process Requirements.....	10
5.1.2 Range of Applications.....	10
5.2 Electroless Nickel Immersion Gold (ENIG).....	10
5.2.1 Process Requirements.....	10
5.2.2 Range of Applications.....	10
5.3 Organic Solderability Preservatives (OSP).....	10
6. PCBA Constructions.....	11
7. Copper Trace Design.....	12
7.1 Trace Width, Spacing and Routing Recommendations.....	12
7.2 Solder Pad to Trace Connections.....	13
7.3 Copper Pour Design Requirements.....	14
8. Solder Mask Design.....	16
8.1 Solder Mask Design for Copper Traces.....	16
8.2 Solder Mask Design for Holes.....	16
8.2.1 Via Holes.....	16
8.3 Alignment Holes.....	16
8.3.1 Positioning Holes.....	17
8.3.2 Buried and Plugged Vias.....	17
8.4 Solder Pad Solder Mask Design.....	17
8.5 Gold-Finger Solder Mask Design.....	18
9. Silkscreen Design.....	19
9.1 Silkscreen Design Considerations.....	19
9.2 Silkscreen Contents.....	19
10. Hole Design.....	20
10.1 Plated and Non-Plated Drill Holes.....	20
10.1.1 General Hole Spacing.....	20
10.1.2 Via Hole Clearance Area.....	20
10.2 Mechanical Hole Design.....	20
10.2.1 Hole Types.....	20
10.2.2 Spacing Requirements.....	21

- 11. Fiducial Mark Design..... 22**
 - 11.1 Classification..... 22
 - 11.2 Fiducial Mark Structure..... 22
 - 11.2.1 Panel Fiducial Marks and Image Fiducial Marks..... 22
 - 11.2.2 Local Fiducial..... 22
 - 11.3 Position of Fiducials..... 22
 - 11.3.1 Panel Fiducial Marks..... 23
 - 11.3.2 Image Fiducial Marks..... 23
 - 11.3.3 Local Fiducial Marks..... 23
- 12. Panelization and Bridge Design.....24**
 - 12.1 V-CUT Scoring..... 24
 - 12.2 Stamp Hole Design..... 25
 - 12.3 Panelization..... 25
 - 12.4 Panelization Methods for Irregularly Shaped PCBs..... 27
- 13. Component Layout Considerations.....28**
 - 13.1 General Component Layout Requirements..... 28
 - 13.2 Reflow Soldering..... 28
 - 13.2.1 General Requirements for SMD Components..... 28
 - 13.2.2 SMD Component Placement Requirements..... 29
 - 13.2.3 Through-Hole Component Layout Requirements for PCBs Undergoing Reflow Soldering..... 31
 - 13.3 Wave Soldering..... 31
 - 13.3.1 SMD Component Layout Requirements for PCBs Undergoing Wave Soldering..... 31
 - 13.3.2 Common Through-Hole Component Layout Requirements..... 33
 - 13.3.3 General Requirements For Wave Soldering Through Hole Components..... 34
- DFM V1.1 List of Revisions..... 35**

1. Brief Introduction

Seed is a hardware innovation platform for makers to grow inspirations into differentiating products and offers accessible technologies with quality and delivery guarantee. Seed Fusion Service offers one-stop prototyping service for PCB (Printed Circuit Board) service, PCBA (PCB Assembly) service and other electronic and mechanical customized services (like CNC Milling, 3D Printing, PCB Layout Service).

Seed has been in the electronics industry for more than 9 years and has accumulated a great deal of manufacturing experience. To help bridge the gap between design and manufacture and put into practice our company values “Grow the Difference”, which aims to help more people make their product come true, we have summarized our 9 years of manufacturing experience in this manual.

Since we are not a professional publisher, there may be some incorrect spellings or vague expressions in this manual, we really appreciate your feedback to help us improve the manual together. We will keep upgrading this manual to make it beneficial to the whole community, if you have any advice or suggestions, please contact us at: (fusion@seed.cc). For more information about the latest prototype service and specification, please head to our website www.seedstudio.com

This specification defines the design parameters for PCB design from a DFM point of view, including the shape, lamination construction, Fiducial design, component layout, conductive traces, holes, solder mask, surface treatments, silk screen design, and so on.

2. Seed Fusion PCB Specification

2.1 Required Manufacturing Files

- [1] **PCB (Printed Circuit Board) only Service:**
Copper Circuit layers, Soldermask layers (one for each circuit layer), Silkscreen layers (optional), Mechanical layer (one per file), Drill file (one per file).
- [2] **PCBA (Printed Circuit Board and Assembly) Service:**
Same as PCB service plus Bill of Materials (BOM).
- [3] **Stencil Service:** Solder Mask / Solder Paste layer. Both Top and Bottom mask / paste layers can be etched onto the same stencil if the effective area of the stencil is large enough to accommodate both layers.

2.2 PCB Gerber File

The Gerber format is an open 2D binary vector image file format. It is the standard file used by the printed circuit board (PCB) industry and software to describe the layers of a board: copper layers, solder mask, silkscreen, etc. Gerber files should be contained inside a single .rar or .zip archive with the following standard file extensions:

Extension	Layer
pcbname.GTL	Top Copper
pcbname.GTS	Top Soldermask
pcbname.GTO	Top Silkscreen
pcbname.GBL	Bottom Copper
pcbname.GBS	Bottom Soldermask
pcbname.GBO	Bottom Silkscreen
pcbname.TXT	Drill
pcbname.GML/GKO	Mechanical / Board Outline
pcbname.GL2	Inner Layer 2 (for ≥ 4 layer)
pcbname.GL3	Inner Layer 3 (for ≥ 4 layer)



Notes:

1. Gerber files must be in RS-274x format.
2. The drill file should be in Excellon format.
3. Gerber files and the Drill file must be stored in the same folder/archive.
4. The board outline must be provided.

2.3 PCB Specification for FR4-TG130

Units: mm [mil] where applicable

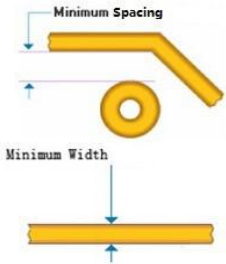
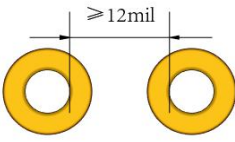
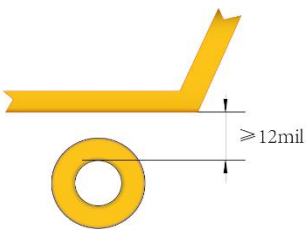
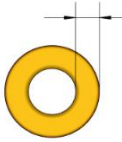
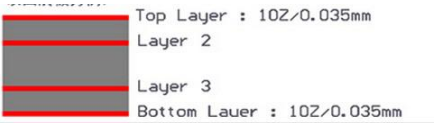
ITEM	DESCRIPTION	SPECIFICATION
Board Dimensions	Minimum dimensions	10 * 10mm Tip: If your board width is smaller than this size, you can make a bigger panel and use slots to separate the boards.
	Maximum dimensions	500 * 500mm
Available Board Layers		1 - 16 layers
Available Board Quantity	Minimum pieces per order	5 pieces
	Maximum pieces per order	8000 pieces
Dielectric Constant		4.2 - 4.7
Dielectric Separation Thickness		0.075 - 5.0
Available Board Thickness	1-2 layers	0.6 / 0.8 / 1.0 / 1.2 / 1.6 / 2.0 / 2.5 / 3.0
	4 layers	0.8 / 1.0 / 1.2 / 1.6 / 2.0 / 2.5 / 3.0
	6-8 layers	1.0 / 1.2 / 1.6 / 2.0 / 2.5 / 3.0
	10 layers	1.2 / 1.6 / 2 / 2.5 / 3.0
	12 layers	1.6 / 2.0 / 2.5 / 3.0
	14 layers	2.0 / 2.5 / 3.0
	16 layers	2.5 / 3.0
Available Board Copper Weights		1oz. 2oz. 3oz.
Board Thickness Tolerance		± 10%
Minimum Trace Width and Spacing		<p>For 1oz: 4mil, 5mil, 6mil [0.1mm, 0.13mm, 0.15mm]</p> <p>For 2oz: 10mil [0.25mm]</p> <p>For 3oz: 15mil [0.4mm]</p>

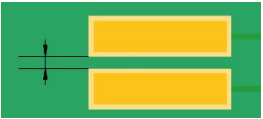
Minimum Trace Width in Inner Layers (for 4 layer boards)		6mil
Minimum Distance Between Trace and Copper Pour		For 1oz ≥ 8mil For 2oz ≥ 12mil For 3oz ≥ 15mi
Minimum Distance Between Vias		12mil
Minimum Distance Between PTH and Trace		12mil
Annular Rings		≥ 0.15mm [6mil]
Outer Layer Copper Thickness	 <p>Top Layer : 10Z/0.035mm Layer 2 Layer 3 Bottom Lauer : 10Z/0.035mm</p>	0.035 - 0.07mm (for 1oz - 2oz)
Inner Layer Copper Thickness	 <p>Top Layer Layer 2 : 0.5oz/0.017mm Layer 3 : 0.5oz/0.017mm Bottom Layer</p>	0.017 (for 0.5oz)
Drilling Hole Diameter (Mechanical)		0.2 - 6.5mm
Minimum Width of Soldermask Dam		Standard: ≥ 0.32mm for Green ≥ 0.35mm for other colors Limit (costs extra): ≥ 0.10mm for Green ≥ 0.13mm for other colors
Diameter of Castellated Holes	Minimum	0.6mm

<p>BGA Pad Dimensions (for track spacing/width)</p>		<p>For 6mil \geq 0.45mm For 5mil \geq 0.35mm For 4mil \geq 0.25mm</p>
<p>Minimum Circuit to Edge Spacing</p>		<p>0.3mm</p>
<p>Minimum Distance Between Inner Trace and NPTH</p>		<p>0.2mm [8mil]</p>
<p>Minimum Silkscreen Height / Trace Width</p>		<p>Height \geq 0.6mm [23mil] Trace Width \geq 0.1mm [4mil]</p>
<p>Perfect Aspect Ratio for Silkscreen Text</p>		<p>1:5</p>
<p>Silkscreen Color</p>	<p>If soldermask is Green/Red/Yellow/Blue/Black</p>	<p>Silkscreen is WHITE</p>
	<p>If soldermask is White</p>	<p>Silkscreen is BLACK</p>
<p>Minimum Distance Between Pad and Silkscreen</p>		<p>0.15mm [6mil]</p>
<p>Minimum Milling Slot Width</p>		<p>0.8mm</p>
<p>Slot Tolerance (Mechanical)</p>		<p>\pm 0.15mm</p>
<p>Board Dimensions for V-cutting</p>	<p>Minimum</p>	<p>70 * 55mm</p>
	<p>Maximum</p>	<p>380 * 380mm</p>
	<p>Minimum Sub-Board Dimensions</p>	<p>8 * 8mm</p>
<p>PCB Production Time</p>	<p>Varies according to specific board features</p>	<p>3 - 14 working days</p>

3. PCB Lamination Structure

3.1 Layer Structure

- [4] For PCB lamination, there are generally two design types: Copper foil structure and Core board structure. The Core board type is used in special multilayered boards and mixed boards.

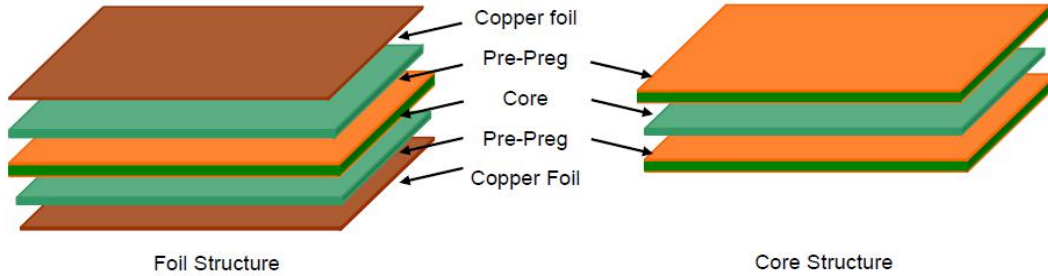

Figure 1: PCB lamination types.

- [5] 0.5oz copper foil is generally used for the copper in the outer layers, whereas 1oz copper foil is generally chosen for the inner layers. Core boards with asymmetric thicknesses should be avoided in the inner layers.
- [6] Symmetrical design considerations include the thickness of pre-preg (pre-impregnated) layers, the type of resin used, the thickness of the copper foil and the type of layer distribution (copper foil layer, circuit layer). The layout should be as symmetrical as possible about the symmetry axis.



Figure 2: Symmetrical board layer design.

4. PCB Dimensions Specification

4.1 Manufactured PCB Dimensions

- [7] The maximum board dimensions is 500 * 500mm, and the minimum boards dimensions is 10 * 10mm.
- [8] The maximum board thickness is 3mm and the minimum is 0.6mm (1-2 layers only).

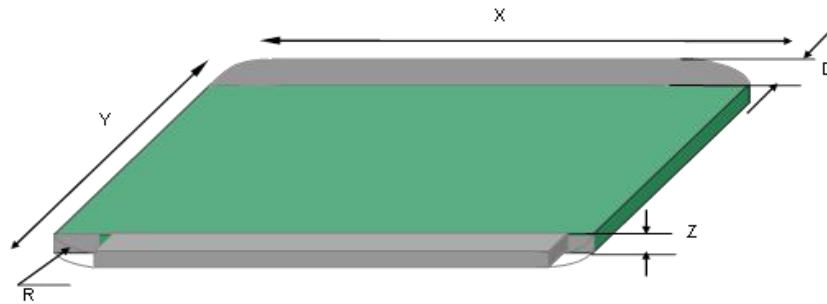

Figure 3: PCB dimensions description.

- [9] Recommended PCB width-to-thickness ratio = $Y / Z \leq 150$.
- [10] Recommended PCB length-to-width ratio = $X / Y \leq 2$.
- [11] For board thicknesses of less than 0.8mm, the copper foil should be evenly distributed to prevent board bending. If there are many small boards, use of a fixture is recommended.
- [12] If the primary side does not meet the clearance area requirements, then the addition of a margin of a width greater than 5mm, along the direction of travel is recommended.

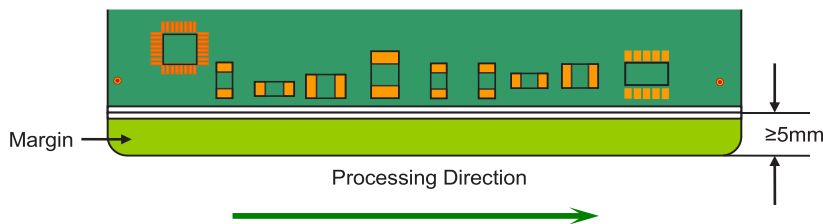

Figure 4: PCB minimum margin dimensions.

- [13] The body of components must not exceed past the edge of the PCB, and must satisfy the following:
 - The distance from the edge of the solder pad (or component body) to the primary side must be more than 5mm.
 - For non-reflow soldering, when a component protrudes out from the PCB, the width of the margin is as follows:

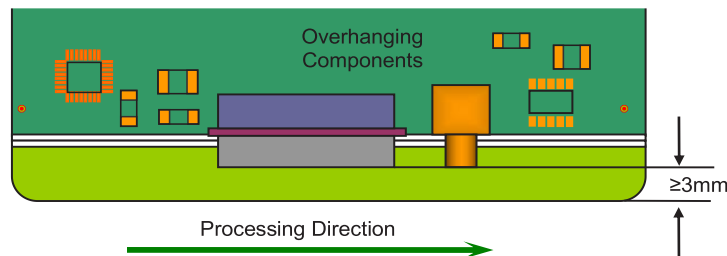

Figure 5: Protruding component margin requirements.

- For non-reflow soldering, when a component protrudes out from the PCB, the component must fit into the margin with 0.5mm clearance as shown in Figure 6.

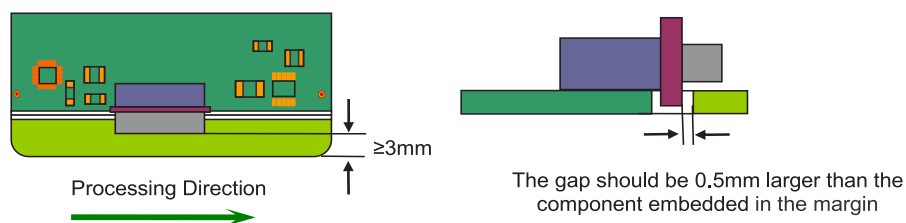

Figure 6: Protruding component margin gap requirements.

5. Surface Treatments

5.1 Hot Air Solder Leveling (HASL)

5.1.1 Process Requirements

[14] The PCB is covered with molten tin-silver alloy and the excess is blown off using hot air. The resulting alloy coating on the exposed copper surfaces must be between 1 μ m to 25 μ m.

5.1.2 Range of Applications

[15] Using HASL, it is difficult to control the thickness of the coating and preserve the precise shape of the copper pads. It is not recommended for PCBs with fine pitch components since the copper pads of fine pitch components typically need to be flatter. In addition, the thermal shock of the HASL process may cause the PCB to warp. Therefore ultra-thin PCBs with a thickness of less than 0.7 mm are not recommended to undergo this type of surface treatment.

5.2 Electroless Nickel Immersion Gold (ENIG)

5.2.1 Process Requirements

[16] Electroless Nickel Immersion Gold (ENIG) is a surface treatment involving plating the copper pads with nickel then immersion gold to help prevent it from oxidation. PCB copper metal surfaces treated with ENIG must have a nickel coating thickness of 2.5 μ m-5.0 μ m, and the immersion gold (99.9% pure gold) layer thickness must be 0.08 μ m-0.23 μ m.

5.2.2 Range of Applications

[17] Due to the resulting flat surface, this process is suitable for PCBs with fine pitch components.

5.3 Organic Solderability Preservatives (OSP)

[18] This process covers the exposed copper pads with a thin coat of an organic compound. Currently, the only recommended organic formula is Enthone's Entek Plus Cu-106A, which results in a thickness of 0.2 μ m-0.5 μ m. Because of the incredibly flat coating, it is especially popular with PCBs with fine pitch components.

6. PCBA Constructions

- [19] PCBs can be designed to have only surface mounted components (SMT), through hole components or both, on one layer or both top and bottom layers.

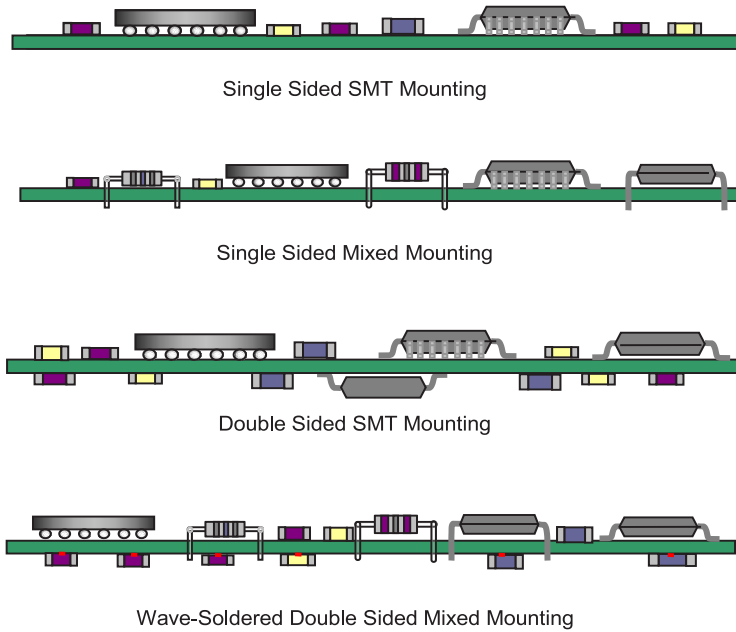

Figure 7: Types of PCB constructions.

7. Copper Trace Design

7.1 Trace Width, Spacing and Routing Recommendations

- [20] The width and spacing of copper traces vary according to the thickness of the copper material and which layer the trace is located. The minimum trace widths and spacing for inner and outer layers of various copper thicknesses is shown in table 1.

Table 1: Minimum trace widths and spacing.

Copper Thickness (oz)	Outer Layer Trace Width and Spacing (mil)	Inner Layer Trace Width and Spacing (mil)
1	4	6
2	6	6
3	8	6

- [21] For outer layers, the distance between the trace and copper pads should satisfy the requirements shown in figure 8.

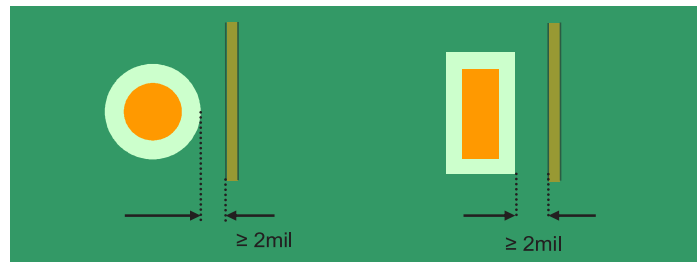

Figure 8: Recommended spacing between trace and pads.

- [22] The distance between outer layer traces, inner layer power/ground planes and ground bus traces to the board edge should be greater than 20mil.
- [23] There should not be any traces going through the metal shell of components (e.g. heatsink). The region of the components' metal shell should have a 1.5mm clearance area around the components' perimeter.

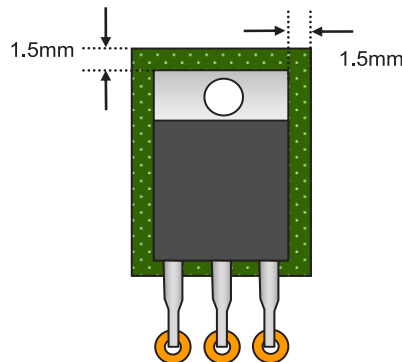

Figure 9: Clearance area of components with metal cases.

- [24] Distance from the trace to non-plated through holes is summarised in table 9.

Table 2: Recommended distance between the trace and the edge of NPTHs.

Aperture Size	Distance From the Trace to the Hole Edge	
	NPTH < 80mil	Mounting hole
Non Mounting hole		8mil
80mil < NPTH < 120mil	Mounting hole	Refer to Mounting hole design
	Non Mounting hole	12mil
NPTH > 120mil	Mounting hole	Refer to Mounting hole design
	Non Mounting hole	16mil

7.2 Solder Pad to Trace Connections

[25] Asymmetry should be avoided in the trace and connected solder pads.

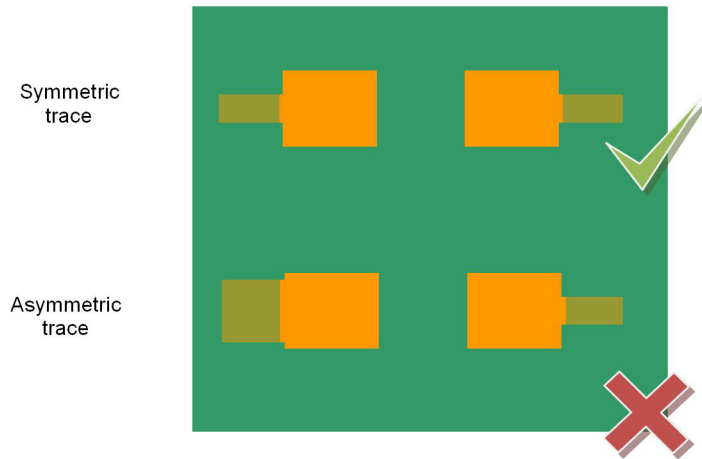

Figure 9: Symmetric and asymmetric traces.

[26] Traces should start from the center of solder pads and not run through the pads.



Figure 10: Starting position of the trace to the pad.



Figure 11: Poor trace and pad alignment.

[27] When the width of the trace is wider than the pad, the trace should not overlap the pad. The trace width should be reduced at the point of contact as shown in figure 12. When adjacent pins of fine pitch components need to be connected, the trace should not run directly between the pads. Instead, it should run outside of the row and connect as shown in figure 13.

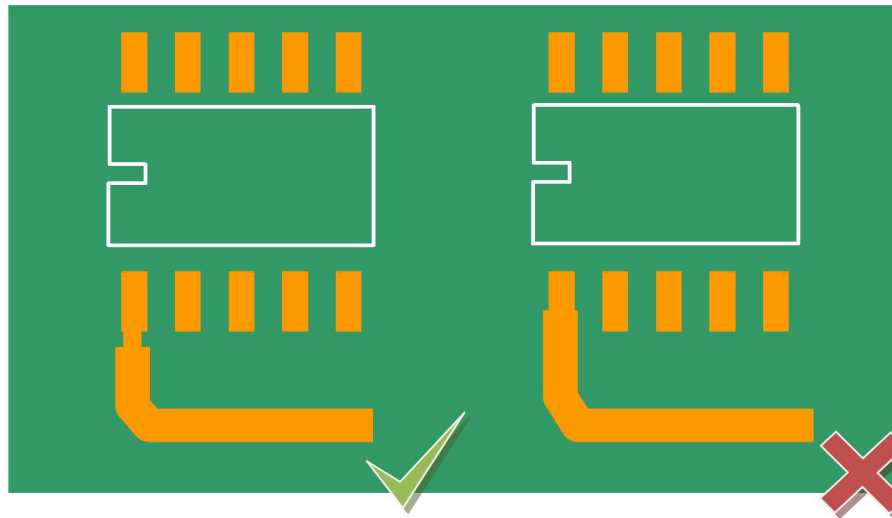

Figure 12: Connecting the trace and pad when the trace width is larger.

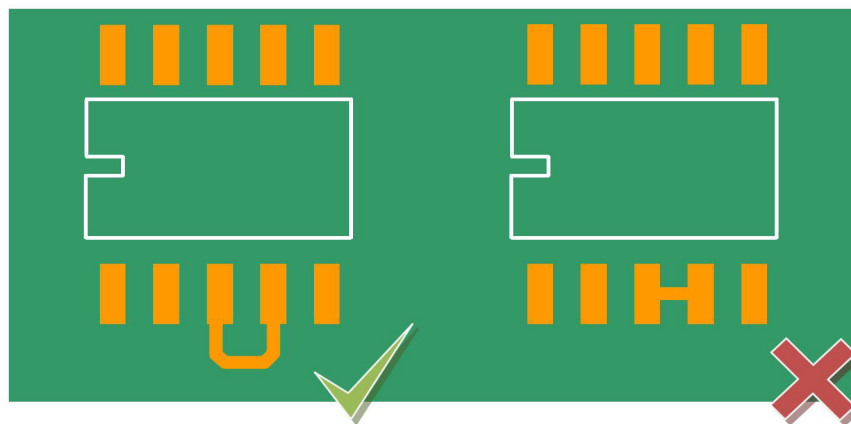

Figure 13: Connecting adjacent pads of fine pitch components.

[28] The below designs are recommended for ensuring a strong connection between a trace and hole.



Figure 14: Connections between the trace and holes.

7.3 Copper Pour Design Requirements

- [29] When the traces on the same layer are unevenly distributed, or the copper distribution in different layers is asymmetric, including a hatched style copper pour grid into the design is recommended.
- [30] If there is a large section of the board without copper, copper pour can be used to even out the copper distribution.
- [31] Recommended copper grid size is about 25mil x 25mil.

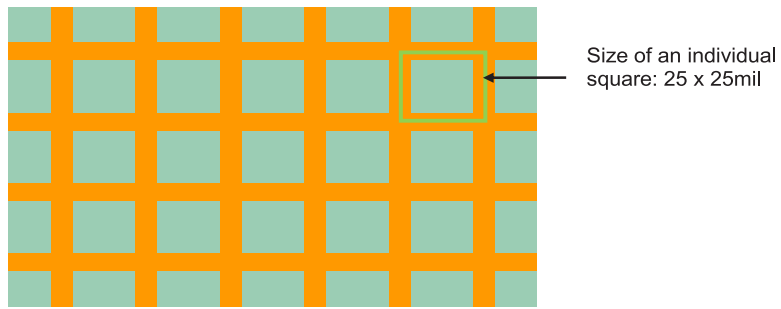

Figure 15: Copper grid design.

8. Solder Mask Design

8.1 Solder Mask Design for Copper Traces

[32] Generally, solder mask is designed to cover copper traces, but in special cases, the traces can be exposed according to the specific purposes.

8.2 Solder Mask Design for Holes

8.2.1 Via Holes

[33] Via holes should have solder mask openings on both sides of the board, centered about the hole, as shown in Figure 16. The required diameter of the opening should be $D + 5\text{mil}$ where D is the diameter of the plated hole.

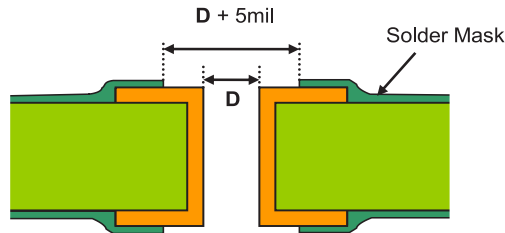

Figure 16: Solder Mask opening for via holes.

8.3 Alignment Holes

[34] For metallic rivet holes, the solder mask opening should be centered about the rivet hole with a diameter $+ 6\text{mil}$ of the plated pad, on both sides.

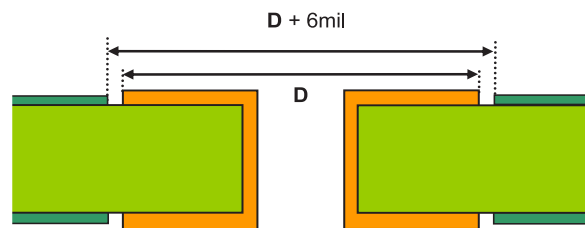

Figure 17: Metallic rivet hole solder mask opening.

[35] For non-plated rivet holes, the solder mask opening should be greater than the clearance area for the screw head.

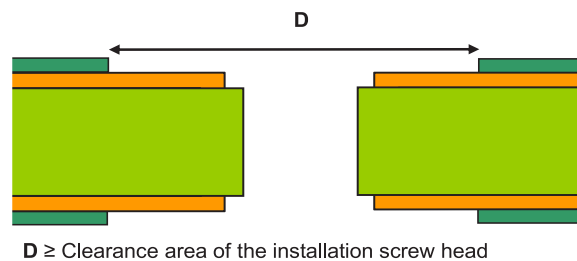

Figure 18: Non-metallic rivet hole solder mask opening.

[36] The solder mask openings for Type A wave soldered holes should satisfy Figure 19.

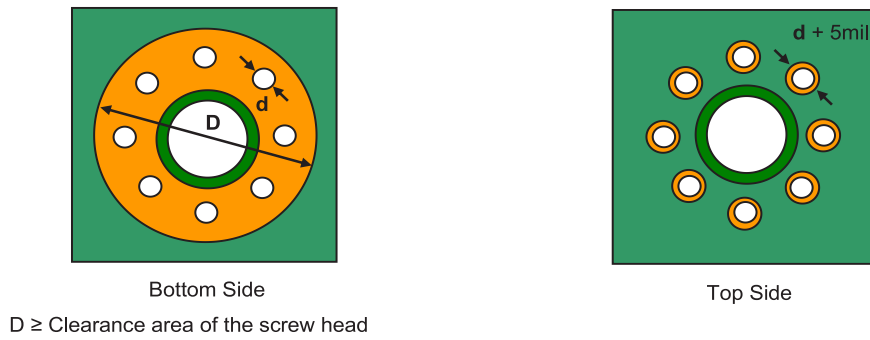

Figure 19: Type A mechanical hole solder mask opening.

8.3.1 Positioning Holes

[37] For non-plated holes, the solder mask opening on both sides of the board should be $D + 10\text{mil}$, concentric about the hole, where D is the diameter of the hole. As shown in Figure 20.

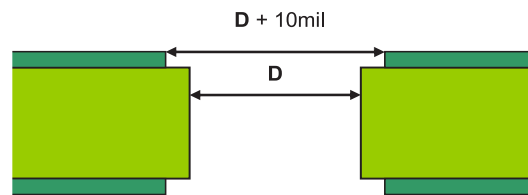

Figure 20: Solder mask opening for non-plated mechanical holes.

8.3.2 Buried and Plugged Vias

- [38] Internal vias (or buried vias) do not require solder mask openings on either side of the board.
- [39] For PCBs requiring wave soldering, or if the board has BGA (or CSP) with a pitch smaller than 1.00mm, the BGA via holes should be plugged.
- [40] If an in circuit testing (ICT) point is added under the BGA, it is recommended to lead out the testing pad from the via hole as shown in figure 21. The diameter of the test pads should be 32mil with a solder mask opening of 40mil.

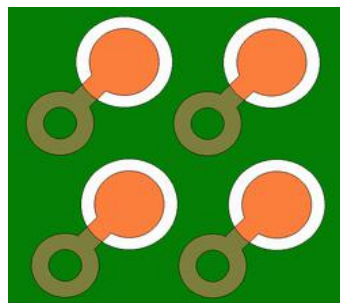

Figure 21: BGA Testing pad.

[41] If the PCB does not require wave soldering, and the pitch of BGA components is greater than 1.00mm, then there is no need for plugged vias. The BGA via itself can be used as a test point. The top side solder mask opening should be 5mil bigger than the diameter of the hole. The bottom side testing pad should be the same as [40] above.

8.4 Solder Pad Solder Mask Design

[42] Solder mask design for copper pads should follow figure 22.



Figure 22: Solder mask openings for copper pads.

- [43] Since PCB manufacturers have limited precision and limits on the minimum width of solder mask openings, solder mask openings should be at least 6mil bigger than pad size (3mil each side), with a minimum solder mask bridge width of 3mil. There must be solder mask separating pads and holes to prevent solder bridges from forming and causing short circuits.

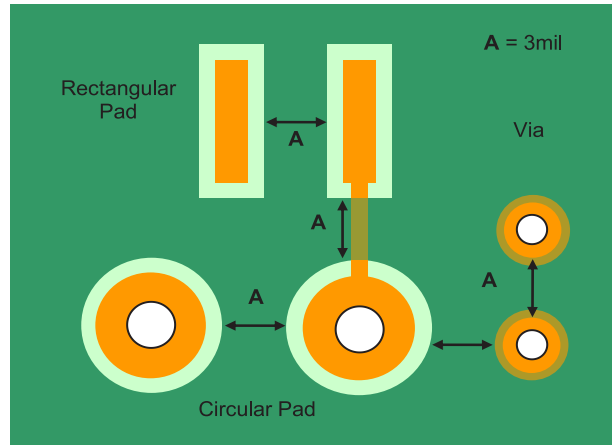

Figure 23: Solder mask openings and material widths for various copper pads.

- [44] Groups of SMD pads less than 0.5mm (20mil) apart or less than 10mil between the pad edges do not need solder mask to separate them and can be opened as a group. See figure 24.

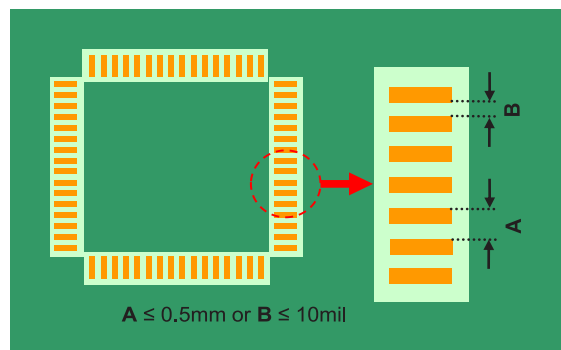

Figure 24: Solder mask openings for fine pitch SMD components.

- [45] Solder mask openings are recommended for heatsink contacts.

8.5 Gold-Finger Solder Mask Design

- [46] The copper pads of gold-finger connectors should open up the solder mask together. The top of the pads (where the trace is connected) should be opened flush with the solder mask material, and the bottom end solder mask opening should close beyond the edge of the board, as shown in figure 25.

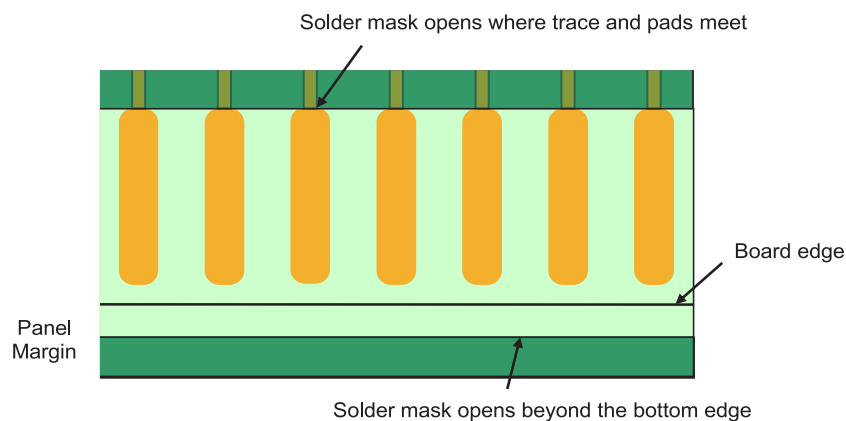

Figure 25: Solder mask opening for a gold-finger.

9. Silkscreen Design

9.1 Silkscreen Design Considerations

[47] General Recommendations

- The width of the silkscreen line should be greater than 5mil. Designers must ensure that the silkscreen character's height is large enough to be read by the naked eye (recommended > 50mil).
- Recommended spacing between silkscreen objects is > 8mil.
- The silkscreen must not overlap with solder pads or Fiducials. The minimum spacing between both is 6mil.
- For high-density PCB design, the contents of the silkscreen can be chosen according to specific requirements. Any silkscreen text should follow the convention of left to right, top to bottom.

9.2 Silkscreen Contents

[48] The contents of the silkscreen can include PCB name, version, component serial number, polarity and direction label, barcode box, mounting hole location code, component footprint, board direction of travel indicator, anti-static label, heatsink label, etc.

[49] PCB board name and version:

Board name and version should be placed on the top side of the PCB. The font should be chosen such that it can be easily read. The top and bottom sides of the PCB should also be marked with 'T' and 'B' (or similar).

[50] Barcode (optional):

- The barcode should be orientated horizontally or vertically on the PCB, refrain from orientating the barcode at any other angle.
- The recommended position of the bar code on a typical board is shown in the figure below; the position on non-standard boards can use this for reference.

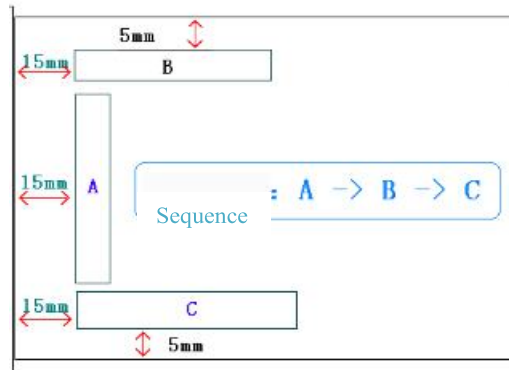

Figure 26: Barcode recommended positioning.

[51] Component silk screen:

- Component labels, mounting holes and positioning holes must be indicated on the silkscreen clearly and should be located by the relevant features.
- Silkscreen characters, polarity and direction labels must not be covered by components.
- For components installed horizontally (such as lying electrolytic capacitors), the silkscreen should include the component outline on the corresponding position.

[52] Processing Direction

For the PCBs that are required to be fed into equipment, such as wave soldering equipment, in a specific orientation, the direction of travel should be indicated on the board. This is also suitable for PCBs with solder thieves and teardrop solder pads.

[53] Heatsink:

For power PCBs that require a heatsink, if the projected area of the heatsink is larger than the component, the actual size must be indicated on the silkscreen.

[54] Anti-Static Label:

The anti-static silk screen should preferentially be placed on the top side of the PCB.

10. Hole Design

10.1 Plated and Non-Plated Drill Holes

10.1.1 General Hole Spacing

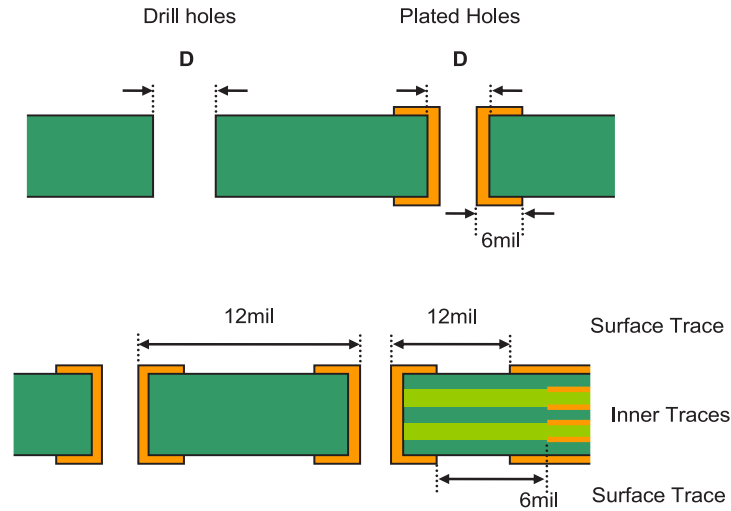

Figure 26: Spacing requirements for holes.

- [55] Here, we define D, as the minimum diameter of the finished drill hole from wall to wall of the PCB material. Where the wall or edge is defined as the bare PCB material wall and the plated walls include the metallized edge. See figure 26. The minimum diameter of the finished drill hole is 0.2mm. For plated holes, the actual finished diameter will be smaller than this.
- [56] The minimum spacing between the edges of two holes must be greater than 12mil, whether plated or not. For plated holes, the measurement of the distance does not include the plating material and is especially important to prevent ion migration (leakage of plating material within layers).
- [57] For plated holes, the plated walls must be at least 12mil away from the edges of surface copper traces.
- [58] For boards with inner copper layers, the inner traces must be 6mil away from the edge of the copper pad of plated holes. This is also to reduce the risk of ion migration.

10.1.2 Via Hole Clearance Area

- [59] Via holes must not overlap solder pads.
- [60] Via holes should not be in a region that extends 1.5mm from the metal shell of any components.

10.2 Mechanical Hole Design

10.2.1 Hole Types

Table 3: Recommended hole designs according to function

Soldering Process	Metal Fastener	Non-Metallic Fastener	Metal Plated Rivet	Non-Metallic Rivet	Board Positioning (Fiducials)
Wave soldering	Type A	Type C	Type B	Type C	
Non Wave soldering	Type B				

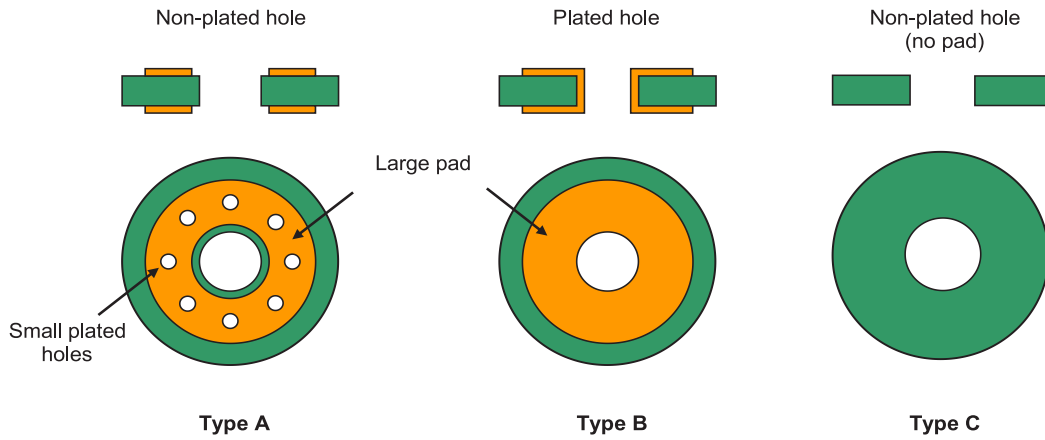

Figure 26: Structure of mechanical holes.

10.2.2 Spacing Requirements

Table 4: Recommended spacing of mechanical holes according to purpose.

Purpose	Fastener Diameter (mm)	Surface Clearance Diameter (mm)
Screws Holes	2	7.1
	2.5	7.6
	3	8.6
	4	10.6
	5	12
Rivets Holes	4	7.6
	2.8	6
	2.5	6
Positioning/Tooling Holes, etc.	≥ 2	Mounting metal component Maximum Clearance Area + A*

* Where 'A' is the minimum spacing between the hole and the trace, with no minimum copper area in the inner layer.

11. Fiducial Mark Design

11.1 Classification

- [61] Fiducial marks are divided into three categories according to their position and role: Panel Fiducials, Image Fiducials and Local Fiducials.

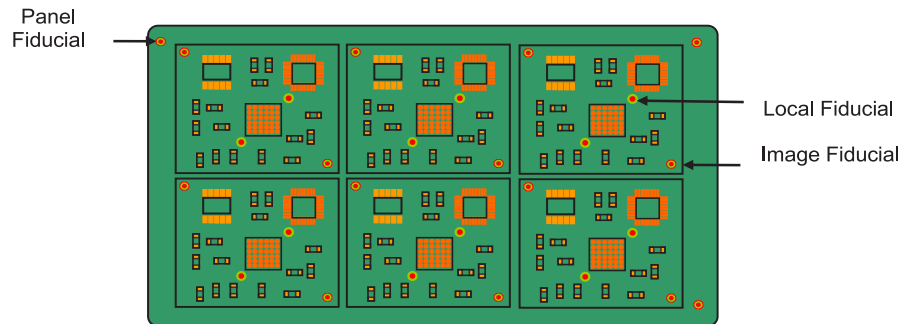

Figure 27: Classification of Fiducial Marks.

11.2 Fiducial Mark Structure

11.2.1 Panel Fiducial Marks and Image Fiducial Marks

- [62] Size/Shape: a solid filled circle with a diameter of 1.0 mm.
 Solder mask opening: 2.00mm in diameter and concentric with the Fiducial.
 Covering copper: an octagonal copper ring 3.00mm in diameter concentric with the Fiducial and clearance area.

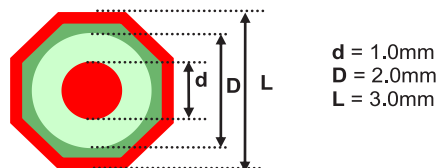

Figure 28: Structure of Panel and Image Fiducials.

11.2.2 Local Fiducial

- [63] Size/Shape: a solid filled circle with a diameter of 1.0mm.
 Solder mask opening: 2.00mm in diameter and concentric with the Fiducial.
 Covering Copper: not needed.

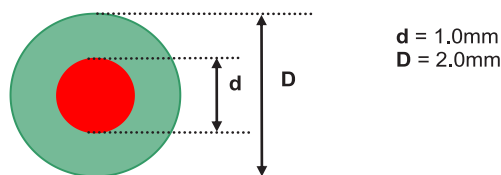

Figure 29: Structure of local Fiducials.

11.3 Position of Fiducials

- [64] In General: PCBs which require SMT automated assembly must have Fiducial marks on the necessary layers. PCBs which only require manual soldering do not require Fiducial marks.
 For single-sided boards, Fiducial marks are only required on the side where the SMD components are to be soldered.
 For double-sided boards, both sides must have Fiducial marks. The position of the Fiducial marks must be generally consistent.

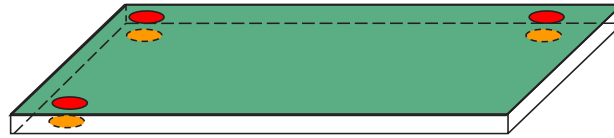

Figure 29: Both sides of a double sided PCB should generally be consistent with each other.

11.3.1 Panel Fiducial Marks

[65] Panel Fiducials and image Fiducials should be located on the panel margins and on individual sub-boards respectively. There should be three panel Fiducials per board and three local Fiducials per sub-board, arranged in an 'L' shape as far from each other as possible, as shown in Figure 30:

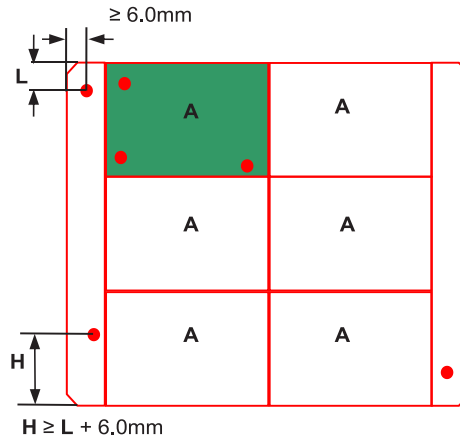

Figure 30: Fiducial positioning requirements on the panel margins and individual boards.

11.3.2 Image Fiducial Marks

[66] There must be three Fiducial marks per sub-board, arranged in an 'L' shape, located as far as possible from each other. The distance from the origin of the Fiducial mark and the edge of the sub-board should be greater than 6.00mm. If it is not possible to ensure that the four edges satisfy this requirement, then the requirement must be satisfied for the primary side at least.

11.3.3 Local Fiducial Marks

[67] For devices with gullwing pins and a pin pitch of $\leq 0.4\text{mm}$, and surface array packaged devices with a pin pitch of $\leq 0.8\text{mm}$, local Fiducial points are required. Two local Fiducial marks are required per component and must be symmetrical on both sides of the origin of the component.

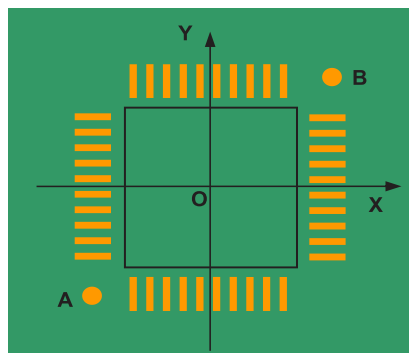

Figure 31: Local Fiducials must be symmetrical about the component's origin.

12. Panelization and Bridge Design

12.1 V-CUT Scoring

- [68] V-cut scoring can be used on PCB panels to separate individual boards. They must run across the entire length of the panel, parallel to a flat edge and not interfere with any component placement.
- [69] For panels incorporating v-cut scoring in their design, the recommended board thickness is greater than 3.0mm.
- [70] For PCB panels that require machine automated depaneling, a clearance area of 1.0mm is required along both sides of the v-cut line (and on both top and bottom surfaces) to protect the components from damage.

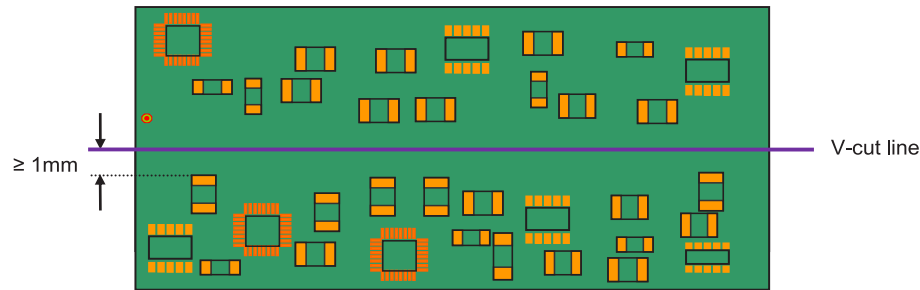

Figure 32: V-cut clearance for PCBs designed for automated depaneling.

At the same time, the structure of the blade of the v-cut scorer must be considered. As shown in figure 33, no components with a height of over 25mm are allowed within a 5mm distance from the v-cut line.

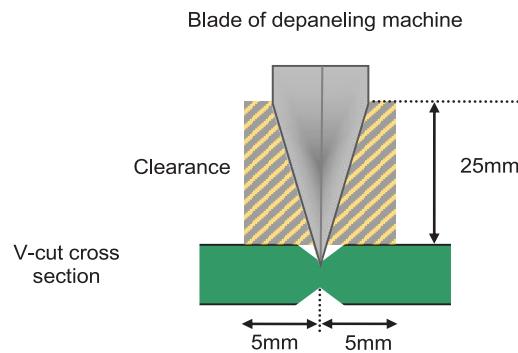

Figure 33: Clearance requirements for the separation of boards with a depaneling machine.

When v-cut design is applied, these conditions must be met in order to protect components during the splitting process, and ensure that the boards will split freely.

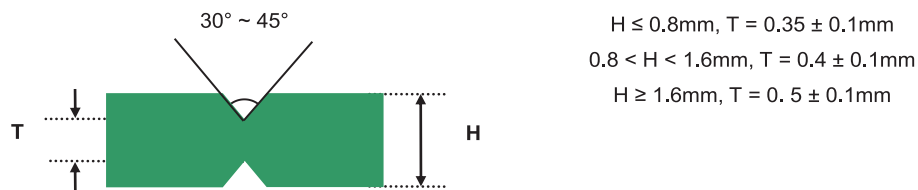

Figure 34: V-cut dimensions.

A safe distance of 'S,' as shown in Figure 4, must be maintained between the v-cut line and any copper traces to avoid damaging the trace. $S \geq 0.3\text{mm}$ is usually satisfactory.

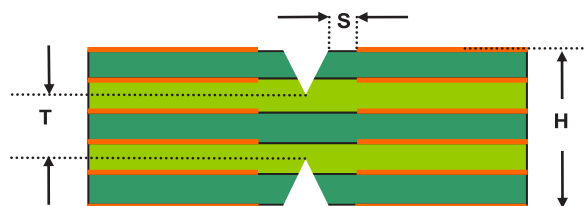

Figure 35: The safe distance (S) between v-cut grooves and copper traces.

12.2 Stamp Hole Design

- [71] The recommended width of milling grooves is 2mm. Milling grooves are often used in situations where a certain distance must be maintained between individual boards on a panel. It is generally used together with V-CUT scoring and stamp holes.
- [72] The distance between the centers of adjacent stamp holes should be 1.5mm. Recommended distance between the two groups of stamp hole is 5mm, as shown in figure 36.

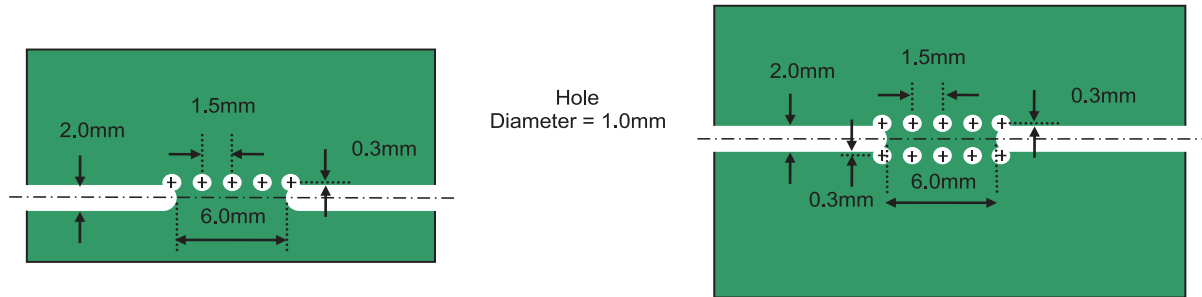

Figure 36: Stamp hole design parameters.

12.3 Panelization

- [73] For PCB boards smaller than 80mm x 80mm, panelization is recommended.
- [74] The designer should consider the utilization rate of the design when choosing the PCB material. This is a key factor affecting the cost of the PCB.
 Note: For some irregular shapes (such as an 'L' shaped board), applying the appropriate panelization mode can drastically improve the utilization ratio of a panel and reduce costs, as shown in figure 37.

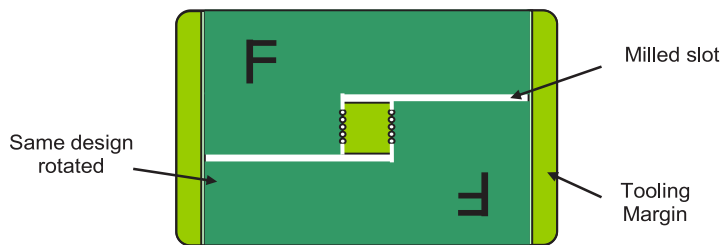

Figure 37: L type PCB layout on a single panel.

- [75] If the PCB is to be processed with reflow soldering and wave soldering techniques, and the cell board size less than 60.0 mm, then no more than two rows should be stacked in one panel (that is, the board should be no more than two boards in height).

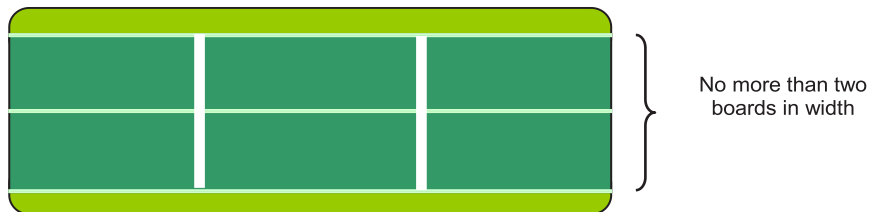

Figure 38: Diagram of panelization width.

- [76] For smaller boards, the number of boards running across the longest side can be greater than 3, but the width should be no more than 150.0 mm, Margins or tooling bars should be added on the longest sides during production to prevent panel deformation.
- [77] Single Board Panelization
 - Regular shape board
 Margins are not required for boards with v-cut grooves that satisfy the clearance area requirement stated in [12.1].

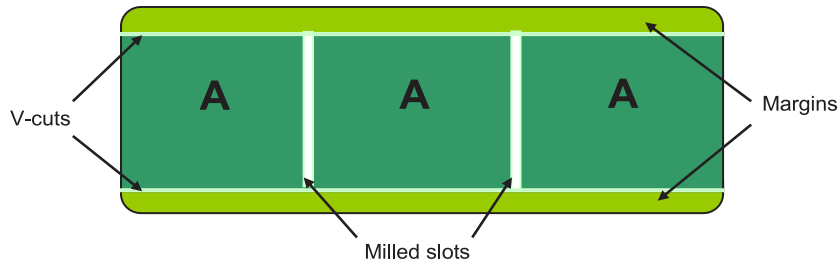

Figure 39: Example layout of step and repeat panelization.

- Irregularly shaped boards
A combination of v-cut lines and milling grooves can be used to shape irregularly shaped boards or boards where components hang over the edge.

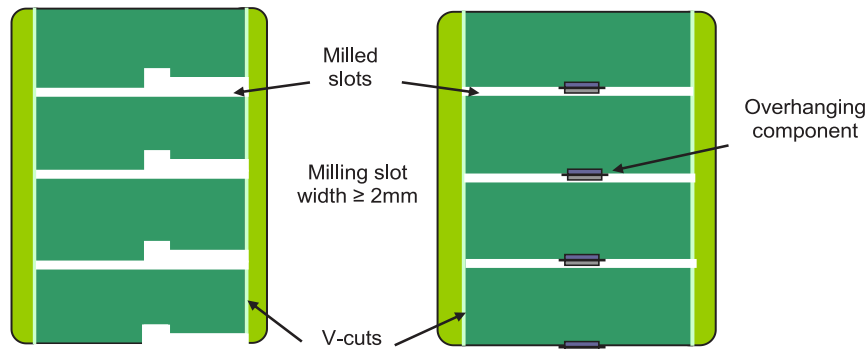

Figure 40: Panelization of irregularly shaped PCBs.

[78] Center Panelization

- Center panelization can be applied to irregularly shaped PCBs. They are arranged in such a way that the outer shape is regular.
- If the two boards do not fit together completely, milling can remove the excess and separate the boards.
- For larger pieces of excess material, the panel may be designed such that the excess pieces can be broken off using stamp hole connections. See figure 41.

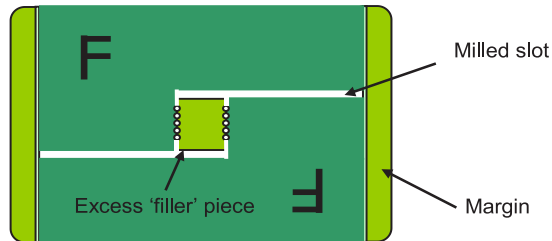

Figure 41: Two irregular boards with the excess connected via stamp holes.

- PCBs with gold finger connectors need to be positioned so that the fingers face outwards as shown in figure 42. This is necessary for the gold plating process.

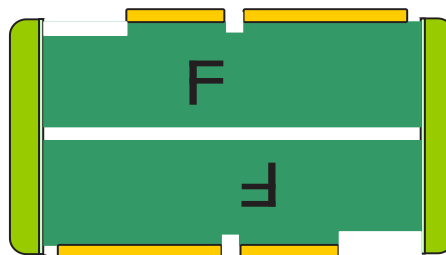

Figure 42: Recommended layout of PCBs with gold fingers.

12.4 Panelization Methods for Irregularly Shaped PCBs

[79] General Principle

- If the assembled PCB does not have a clearance area of 5mm along the edge of the board, margins/tooling bars should be added along its perimeter.
- If the PCB is irregular in shape, for example, a corner is missing or a segment cuts into the board, block filler pieces should be used to make the outline more rectangular in shape to aid assembly.

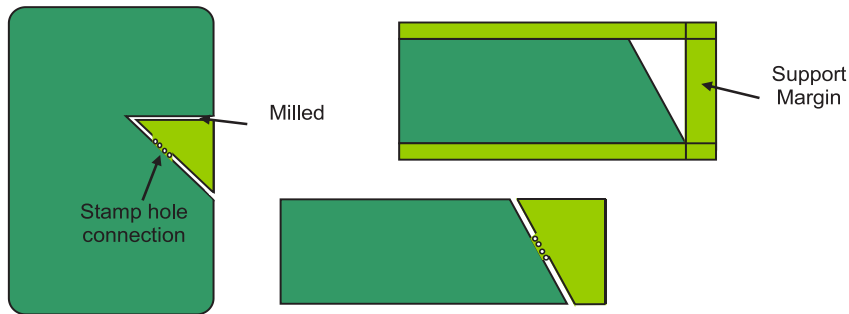

Figure 43: Simplification of the outline of irregularly shaped boards via the addition of filler pieces/margins.

- [80] It is recommended that SMT and wave soldering techniques be used for irregular boards with filler pieces larger than 35mm x 35mm. For filler pieces greater than 50mm in length, two sets of stamp holes should be used, otherwise, one set is satisfactory.

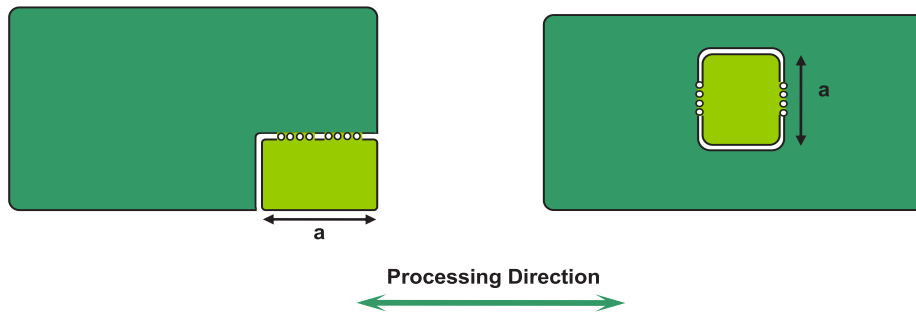

Figure 44: Stamp hole placement for filler pieces greater than 50mm in length, where 'a' is the length of the filler piece.

13. Component Layout Considerations

13.1 General Component Layout Requirements

- [81] Through-hole components with polarity or direction requirements should maintain a consistent alignment throughout the layout and should be arranged as neat as possible. For SMD devices, if they cannot be placed in the same direction, they should be consistent in both X and Y directions for example for tantalum capacitors.
- [82] If the component needs to be glued, ensure the component has at least 3mm space.
- [83] For PCBs which need have heatsinks, the location and orientation of the heatsink should be considered. There must be sufficient space to ensure that the heatsink does not touch other components. Ensure that a minimum distance of 0.5mm is maintained:
 1. Thermosensitive devices (such as resistive capacitors, crystal, etc.) should be situated far away from heat producing components.
 2. Thermosensitive devices should be placed by an air outlet. Tall components devices should be placed behind shorter components to facilitate air flow.

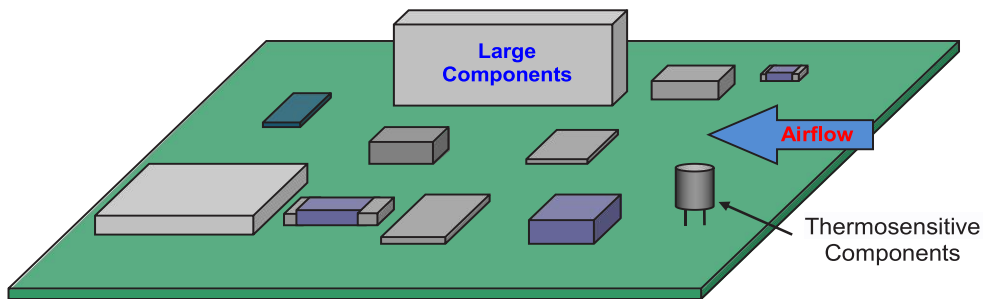

Figure 45: Placement of thermosensitive components.

- [84] The distance between the devices must satisfy the required space for normal operation, for example, a memory card socket.

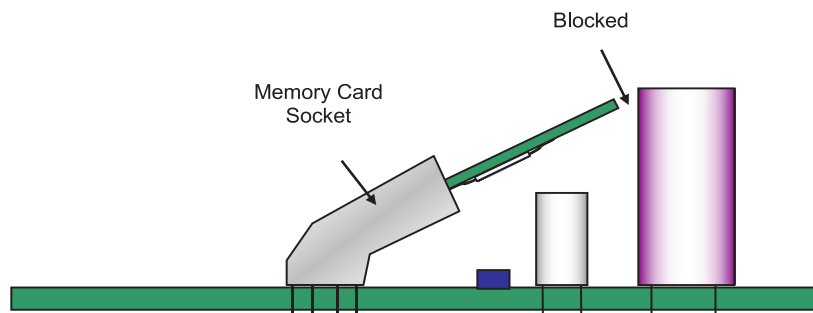

Figure 46: Blocked socket.

- [85] Metal parts with different properties or devices with metallic cases must not touch each other. A minimum distance of 1.0mm should be maintained between components.

13.2 Reflow Soldering

13.2.1 General Requirements for SMD Components

- [86] It is recommended that fine pitch devices be placed on the same side of the PCB and larger devices (such as inductors) be arranged on the top side.
- [87] Polarized components should be aligned such that all the positive poles are on one side of the board and negative poles on the other where possible. Avoid positioning taller components next to shorter ones, which may hinder inspection. A viewing angle of no less than 45 degrees must be maintained throughout the layout to aid manual solder joint inspection.

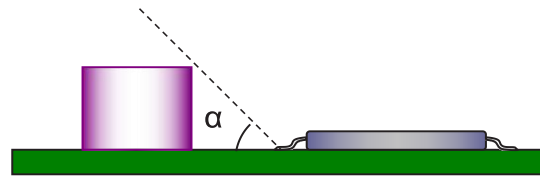

$$\alpha \leq 45^\circ$$

Figure 47: Solder joint inspection angle.

- [88] Surface array devices such as CSP, BGA, etc. must have a clearance area of 2mm, but 5mm is ideal.
- [89] In general, surface array devices should not be placed on the bottom side of the board (the side with fewer components). The region on the other side of the board, with an additional boarder of 8mm, should not contain any surface array devices, see Figure 46.

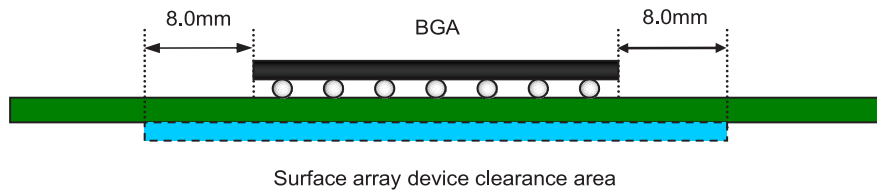
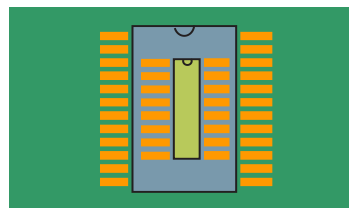

Figure 48: Layout requirements for surface array devices.

13.2.2 SMD Component Placement Requirements

- [90] All SMD components shall be smaller than 50mm on at least one side.
- [91] It is not recommended for two surface-mount gullwing pin devices to overlap, for example, SOP packages as shown in Figure 49.



Not recommended

Figure 49: Incompatible layout of two SOP footprints.

- [92] In the event that solder pads are shared between two SMD components, the packages must be the same, see figure 50.

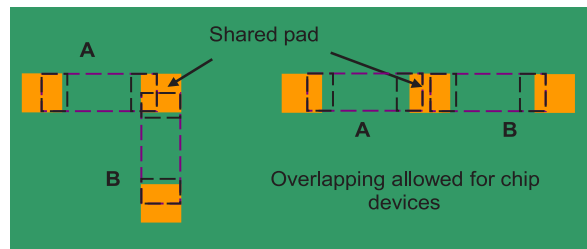
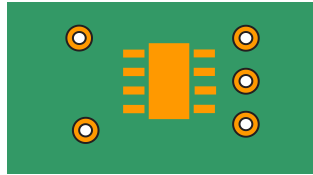

Figure 50: Sharing of solder pads for SMD components.

- [93] Through-hole devices and SMD components are allowed to overlap when it can be confirmed that the SMD pad and the solder paste printed thereon has no effect on the soldering of the through-hole device. See figure 51.



Through-hole components may overlap SMD components

Figure 51: Acceptable through-hole and SMD component layout design.

- [94] The required distance between SMD components is:
 Same component: $\geq 0.3\text{mm}$
 Different components: $\geq 0.13 \times h + 0.3\text{mm}$ (where h is the maximum height difference of the surrounding neighbors)

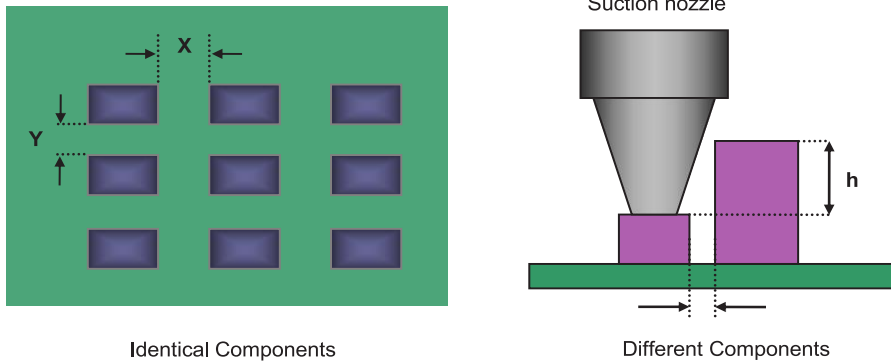

Figure 52: Spacing requirements for components.

- [95] For PCBs requiring solder reflow, SMT device spacing varies according to the table 5. The quoted value is the largest of the two: either the pad or the body of the device, whichever is most applicable. The values in brackets represent the lowest acceptable value.

Table 5: Component spacing recommendations.

(Units in mm)	0402 ~ 0805	1206 ~ 1810	STC3528 ~ 7343	SOT / SOP	SOJ / PLCC	QFP	BGA
0402 ~ 0805	0.40	0.55	0.70	0.65	0.70	0.45	5.00 (3.00)
1206 ~ 1810		0.45	0.65	0.50	0.60	0.45	5.00 (3.00)
STC3528 ~ 7343			0.50	0.55	0.60	0.45	5.00 (3.00)
SOT / SOP				0.45	0.50	0.45	5.00
SOJ / PLCC					0.30	0.45	5.00
QFP						0.30	5.00
BGA							8.00

- [96] The distance between fine pitch devices and the board edge must be greater than 10mm so as to not adversely affect printing quality. Ideally, the distance between the bar code frame and the surface mounted components should meet the requirements shown in Table 6 to preserve the quality of the solder.

Table 6: Recommended spacing requirements between printed barcodes and component footprints

Component Type	Pitch \leq 1.27mm's Gullwing Pin (e.g. SOP, QFP) and Surface Array Components	0603 Size and Greater SMD Chip Components and Other Footprints
Minimum Spacing, D	10mm	5mm

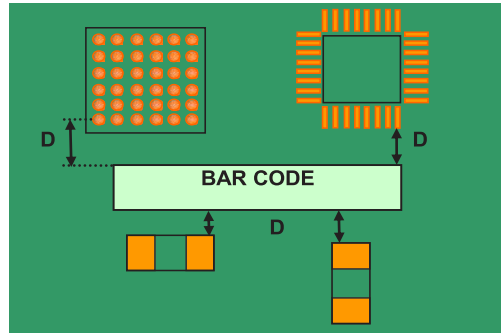

Figure 53: Layout requirements of printed barcodes and components

13.2.3 Through-Hole Component Layout Requirements for PCBs Undergoing Reflow Soldering

[97] For PCB with non-transmission side larger than 300mm, heavier through-hole components should not be placed in the middle of the PCB. This will reduce the board deformation caused by the weight of the components during soldering.

[98] To facilitate plug-in sockets, the socket should be placed where convenient.

[99] The distance between through-hole components should be $> 10\text{mm}$.

[100] The distance between through-hole components and the margin should be $\geq 10\text{mm}$, and board edge should be $\geq 5\text{mm}$.

13.3 Wave Soldering

13.3.1 SMD Component Layout Requirements for PCBs Undergoing Wave Soldering

[101] Wave soldering is suitable for the following SMD components:

- Chip resistors, capacitors, and inductors that have a package size greater or equal to 0603 and standoff value less than 0.15mm.
- SOP packages with pitch $\geq 1.27\text{mm}$ and Standoff value $\leq 0.15\text{mm}$.
- SOT packages with pitch $\geq 1.27\text{mm}$ and visible pins.

Note: The pins of SMD components undergoing wave soldering must be less or equal to 2mm. Other components must be less than 4mm in height.

[102] The long axis of SOP package components should be perpendicular to the direction of travel of the solder wave in the wave soldering process. SOP components also need extra pads at the end of the solder pad rows to act as 'solder thieves,' see Figure 54.

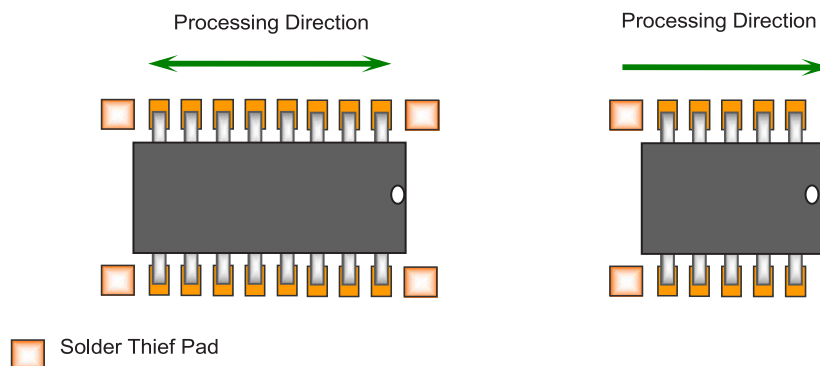

Figure 54: Solder thief pad placement for SOP packages undergoing wave soldering.

[103] The orientation of SOT-23 package components should be such that the pins point parallel to the direction of travel.

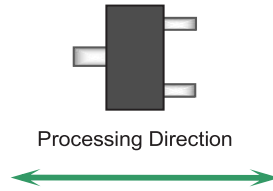

Figure 55: Orientation of SOT-23 packages undergoing wave soldering.

[104] General component spacing principles: In order to reduce shadow effect problems caused by wave soldering, certain distances must be maintained between components and individual pads.

- For components of the same type according to Table 7:

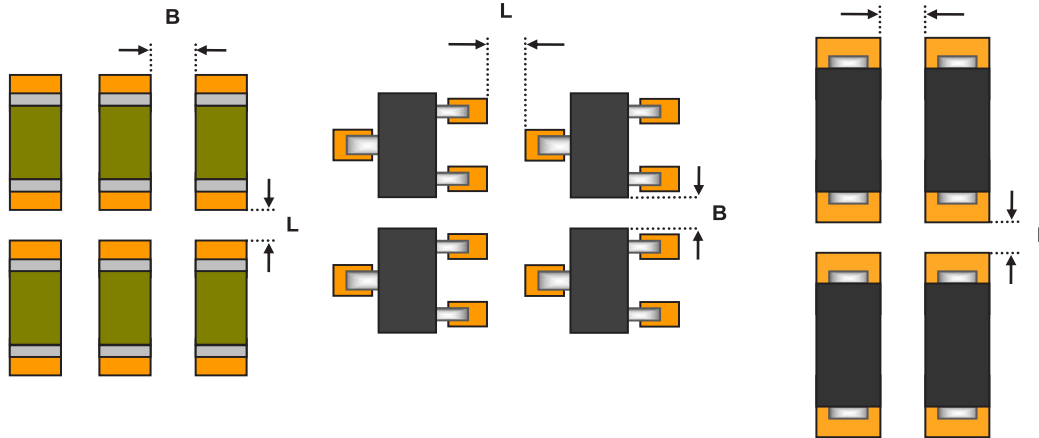

Figure 56: Layout of components of the same type.

Table 7: Distances between components of the same type.

Footprint	Pad Spacing L (mm/mil)		Component Spacing B (mm/mil)	
	Minimum Spacing	Recommended Spacing	Minimum Spacing	Recommended Spacing
0603	0.76/30	1.27/50	Type 0.76/30	1.27/50
0805	0.89/35	1.27/50	0.89/35	1.27/50
≥ 1206	1.02/40	1.27/50	1.02/40	1.27/50
SOT	1.02/40	1.27/50	1.02/40	1.27/50
Tantalum Capacitors 3216 and 3528	1.02/40	1.27/50	1.02/40	1.27/50
Tantalum Capacitors 6032 and 7343	1.27/50	1.52/60	2.03/80	2.54/100
SOP	1.27/50	1.52/60	---	---

- For different component types, the solder pad edge spacing should be $\geq 1.0\text{mm}$. Distance requirements are shown in Figure 57 and Table 4.

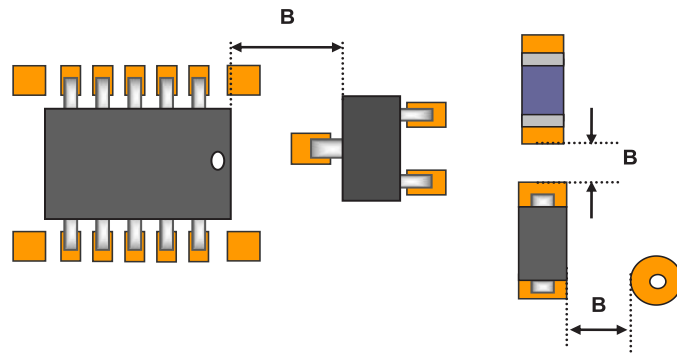

Figure 57: Layout of components of different types and PCB structures.

Table 8: Distances between components of different types and PCB structures.

Footprint (mm/mil)	0603 - 1810	SOT	SOP	Through-Holes	Vias	ICT Point	Solder Thief Pad Edge
0603 - 1810	1.27/50	1.52/60	2.54/100	1.27/50	0.6/24	0.6/24	2.54/100
SOT	1.27/50		2.54/100	1.27/50	0.6/24	0.6/24	2.54/100
SOP	2.54/100	2.54/100		1.27/50	0.6/24	0.6/24	2.54/100
Through-Holes	1.27/50	1.27/50	1.27/50		0.6/24	0.6/24	2.54/100
Vias	0.6/24	0.6/24	0.6/24	0.6/24	0.3/12	0.3/12	0.6/24
ICT Point	0.6/24	0.6/24	0.6/24	0.6/24	0.3/12	0.6/24	0.6/24
Solder Thief Pad Edge	2.54/100	2.54/100	2.54/100	2.54/100	0.6/24	0.6/24	0.6/24

13.3.2 Common Through-Hole Component Layout Requirements

- [105] In addition to the special requirements relating to the specific structure of the device, through-hole components must be placed on the top layer.
- [106] The spacing between adjacent components is shown in figure 58.

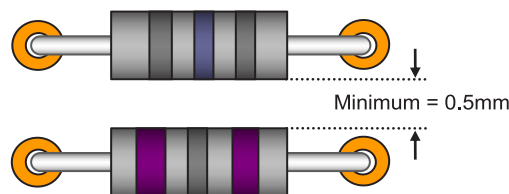

Figure 58: Distance between through-hole components.

- [107] In order to facilitate manual soldering and maintenance/repair the conditions shown in figure 59 must be satisfied.

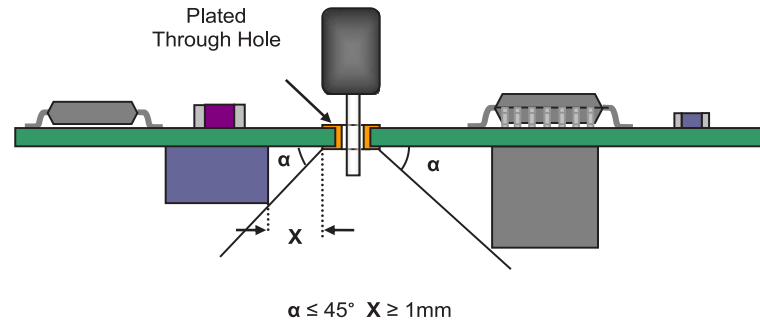

Figure 59: Through-hole placement requirements.

13.3.3 General Requirements For Wave Soldering Through Hole Components

[108] The optimum component pitch is $\geq 2.0\text{mm}$, the distance between the solder pad edges must be at least 1.00mm as shown in Figure 60. In addition, the component bodies must not interfere with each other.

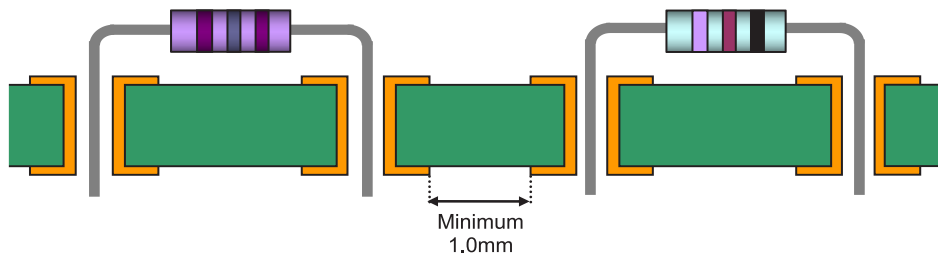

Figure 60: Through-hole component layout for wave soldering.

[109] For a long row of through hole component holes, the components should be positioned such that the row is parallel to the direction of travel of the solder wave. In special circumstances where the row of pads must be aligned perpendicular to the direction of travel, suitable adjustments should be made, such replacing the standard pads with elliptical pads. When the spacing between adjacent pad edges is $0.6\text{mm} - 1.0\text{mm}$, the implementation of oval pads or solder thieves is recommended.

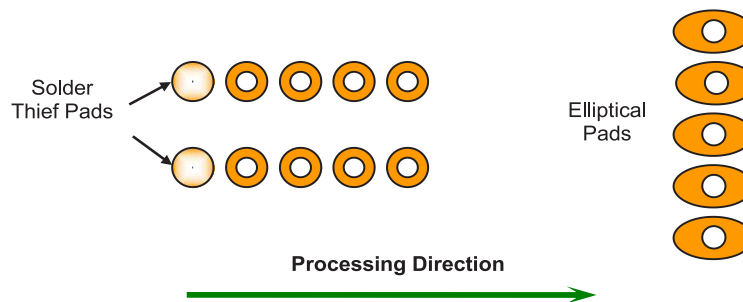





Figure 61: Solder pad alignment relative to board's direction of travel through the wave soldering equipment.

DFM V1.1 List of Revisions:

- Renamed headings.
- Fonts and styles changed.
- Reordered content, moved design considerations to the front and component layout considerations to the end (figures also re-ordered).
- Removed Appendix (moved to section 6)
- Re-wrote '*Files for Manufacture Requirements*' chapter and moved to chapter 2.
- Restructure so all new chapters start on a new page.
- Added a gap between the section number (e.g. [1]) and the first word.
- Edited layout of specification to fit on exactly 3 pages.
- Formatted specification table and most other tables (centered, corrected spacing, capitalized headings).
- Added unit conversions for some entries (mil/mm) and rounded some units.
- Removed '≥' sign where the word 'minimum' was already used.
- Added new points ([7], [8] and [19]).
- Removed point [82] – not relevant.
- Reworded point [23] Surface Array Device clearance area.
- Removed 'Description:' labels since they are not necessary.
- Changed wording from required to recommended, since many of the stricter requirements apply only to advanced designs but will still be accepted for simpler designs.
- Silkscreen requirements changed to optional.
- Re-wrote chapter on vias to a chapter on drill holes in general that is consistent with the specification.
- Changed recommended stamp hole width from 5mm to 6mm (consistent with 1.5mm hole spacing).
- Removed section '*[12] Symmetrical Panelization*' - not relevant.
- Removed 1/3 stamp hole recommendation – not consistent.
- Modified figures, descriptions and layout. Major changes (numbers refer to the old document):
 - o Figures 1/2/3/4/5/7/8/10/13/14/16/17/21/25/26/28/32/36/43/55 corrected conversion errors.
 - o Figures 2/5/31/32/39/40/45/46/47/48/49/51 redesigned.
 - o Grouped all chapter 14 figures into one figure.
 - o Direction of Travel renamed to Processing Direction.
 - o Removed unnecessary labels.
- Modified and removed tables. Major changes:
 - o Removed table 7/10/11 – incomplete/inaccurate.
 - o Changed values in Table 8 to match specification.
 - o Removed last two columns of Table 6.

Seeed provides complete Original Equipment Manufacturing services for a wide variety of electronic hardware, lifting your design from paper to production. Offering the entire package from PCB manufacture, parts procurement, turn-key assembly, mechanical parts manufacture, packaging services, quality inspections down to shipping provisions, complete with dedicated account managers and expert engineers, Seeed can help you realize your ideas economically and efficiently. Take a look below for more insight on how and what we can achieve together. If that interests you, we invite you to find out more by contacting us via oem@seeed.cc. We look forward to hearing from you.

PROCESS FLOW	TASKS	INPUT	OUTPUT	TURNAROUND TIME
 Inquiry	<p>A. Sign NDA (optional)</p> <p>B. Client provides production documents according to the input list</p> <p>C. Seeed analyses the RFQ</p> <p>D. Seeed completes the RFQ checklist</p> <p>E. Seeed optimizes the inquiry and provides feedback</p>	<ul style="list-style-type: none"> ▪ BOM ▪ PCB Gerber files ▪ Test plan ▪ PCB Specification ▪ Quality request ▪ Parts list ▪ Mechanical parts design file (Opt.) 	<ul style="list-style-type: none"> ▪ NDA ▪ RFQ Checklist 	1-2 days client interaction
 Quotation	<p>A. Seeed provides initial quotation and suggests alternatives where possible</p> <p>B. Client provides feedback on alternatives</p> <p>C. Seeed finalizes the quotation</p>	<ul style="list-style-type: none"> ▪ Initial quotation ▪ Alternatives suggestion ▪ Final quotation 	<ul style="list-style-type: none"> ▪ Quotation Accepted 	PCBA: 3-7 days PCBA + Boxbuild: 5-10 days
 Project Kickoff	<p>A. Client sends out the formal PO</p> <p>B. Seeed issues an invoice</p> <p>C. Seeed initiates the order after payment has been received</p> <p>D. Seeed provides feedback DFM report</p>	<ul style="list-style-type: none"> ▪ PO ▪ Invoice ▪ Payment 	<ul style="list-style-type: none"> ▪ DFM report 	2-4 days after receiving PO or first payment subject to business terms

PROCESS FLOW	TASKS	INPUT	OUTPUT	TURNAROUND TIME
 Production Process-NPI	<ul style="list-style-type: none"> A. Material procurement B. Incoming material inspection C. Prepare for manufacturing, tester development, SOP, stencils, tooling, and quality control standard etc. D. Production of 3-5 prototypes E. Testing and debugging 		<ul style="list-style-type: none"> ▪ NPI report 	10-30 days from material purchasing to 1-100 pieces NPI build
 Production	<ul style="list-style-type: none"> A. SMT & Reflow Soldering B. Selective Wave Soldering C. Solder paste inspection (SPI) D. 100% PCBA Functional test E. Product Assembly F. Final testing G. Packaging H. Final quality inspection 		<ul style="list-style-type: none"> ▪ Production Report 	30-45 days from material purchasing to complete production assembly
 Delivery	<ul style="list-style-type: none"> A. Global door-to-door delivery B. Drop-shipping 		<ul style="list-style-type: none"> ▪ Tracking information 	<p>Expressway:</p> <ul style="list-style-type: none"> - 3-5 days to North America or Europe - 1-3 days to APAC <p>By air:</p> <ul style="list-style-type: none"> - 5-10 days to North America or Europe - 3-5 days to APAC <p>By sea:</p> <ul style="list-style-type: none"> - 15-20 days to North America - 30-40 days to Europe - 7-10 days to APAC
 After-sales Service	<ul style="list-style-type: none"> A. Failure Analysis or RMA (returned material authorization) B. Customer service satisfaction survey and continued improvement C. Timely business performance review 			<p>Failure Analysis based on customer's feedback:</p> <ul style="list-style-type: none"> -24 hours feedback customer containment action <p>7 -10 days feedback root cause analysis and corrective action</p>

Seed Fusion Service

One-stop prototyping service

Layout Service

Online instant quote
Experienced Engineers

PCB service

Layers 1-16
Free Color Options 6
Thickness 0.6-3.0mm
Copper Weight 1-3oz
Special Deals: \$4.9 for 10 pieces

PCBA service

One-stop PCBA without sourcing component
Online instant quote

3D printing/CNC/Laser Cutting

Online instant quote
More than 10 material available

Open Parts Library

In house stock for assembly
Eagle, Kicad, Altium library available
More than 600 components

Why Choose us ?

- ✓ Online instant quote without hidden cost
- ✓ Quick turn service with 24 hours build time
- ✓ Over 9 years experience with trusted capability
- ✓ Professional and thoughtful technical support
- ✓ Free online DFM Review (Design for Manufacturing)
- ✓ One-Stop Service, from electronic to mechanical
- ✓ 100% quality guarantee, offer free re-do if needed